

EX-D ENCLOSURES AND DISTRIBUTIONS

Series GHG 64: Modular design for almost any application

The optimized solution

Regardless of whether for offshore applications or for use in harsh environments found in chemical plants and refineries: thanks to the optimised selection of materials, combined with a high quality powder coating ($> 100 \mu\text{m}$) and the use of stainless fixing materials, the new flameproof light alloy enclosures of the series.

6 GHG 64 with flat flamepaths can be used in all areas. The modular design, the wider temperature range ($-55 \text{ }^\circ\text{C}$ to $+55 \text{ }^\circ\text{C}$) and the compact design are further highlights of this product range.

The computer-optimised enclosure design with a significant weight reduction ensures a pressure resistance up to $-55 \text{ }^\circ\text{C}$. The 11 different enclosure sizes are compatible and can, therefore, be combined to suit requirements. They are interconnected using flameproof bushings and, as a result, individual, large and complex customised solutions up to 1150 A can be assembled using enclosures in different sizes, e.g. a wide variety of control systems, as well as control devices, motors starters and trace heating distributions up to 1150 A.

A fast and economical distribution of high currents is also possible using a busbar system.

The special cost advantage: as they are built into Ex-d enclosures, not only low-priced, standard industrial built-in components, but also complex units (e.g. converters) can also be used in hazardous areas. The high dissipation loss of the enclosures ensures a high degree of flexibility when selecting components. The result: solutions that suit your applications exactly!

Extract from our modular construction system:

- Enclosure in 11 different sizes
- Wide variety of Ex-d actuators for push-buttons, circuit breakers, main switches, etc.
- Stainless steel or powder-coated sheet metal
- Ex-e enclosures
- Two busbar systems (Ex-d up to 1150 A and, standard version, Ex-e up to 630 A)
- Free choice of suitable cable entries (Ex-d and Ex-e), e.g. from CEAG and Capri
- Hinged cover with up to 110° opening angle
- Frameworks for wall and floor mounting
- Windows



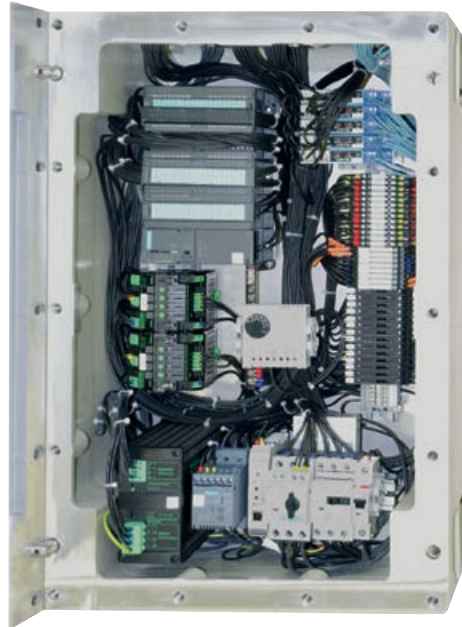

Explosion protection made to measure!

Optimised enclosure sizes enable us to meet the needs of the customer exactly as possible. A wide variety of industrial components, e.g. contactors, MCBs, RCDs, PLCs, WLAN, time elements, electronic components or terminals, can be operated in hazardous areas in a space-saving and safe manner using the 11 enclosure sizes that are now available.

The better the size of the enclosure suits the built-in components, the more convenient the mounting on site.

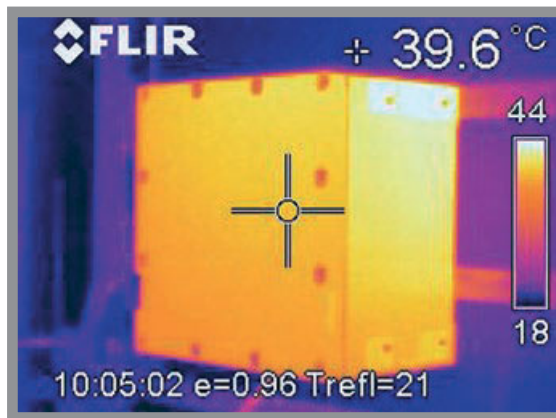

Optimum utilization of heat dissipation!

Optimum utilization is made possible by a complex assessment of the permissible heat dissipation in worst case situations, in combination with a simultaneous observance of the maximum surface temperature that must not exceed the permissible limiting temperature at any time. As a result, the permissible values are considerably higher than those normally given in the standard documentation.

Thus, a higher dissipation is possible in an enclosure of the same size, while the surface temperature stays within the permissible limits! This saves space and allows more flexibility during planning.



The following sizes are available:

- Size 11:** 650 x 650 x 442 mm
- Size 10:** 430 x 650 x 440 mm
- Size 9:** 430 x 650 x 284 mm
- Size 8:** 430 x 430 x 284 mm
- Size 7:** 320 x 430 x 284 mm
- Size 6:** 320 x 430 x 191 mm
- Size 5:** 320 x 320 x 284 mm
- Size 4:** 320 x 320 x 191 mm
- Size 3:** 210 x 320 x 284 mm
- Size 2:** 210 x 320 x 191 mm
- Size 1:** 210 x 210 x 191 mm

| With an eye to detail: Innovative and well-thought-out |

In addition to the innovative overall concept, it is the many innovative details of the GHG 64 enclosure series are that convince our customers.

Intelligent hinge technique

Optionally, the stainless steel hinges with their new technique make it possible to open enclosures even if they are mounted directly adjacent to each other. Once the captive screws have been undone, the cover can be swung open easily thanks to the spring-mounted pull/turn hinges. This saves space, simplifies maintenance work and speeds up repairs and the replacement of built-in components – a cost factor that should not be underestimated! The flat flamepath is protected against damage.

hinge

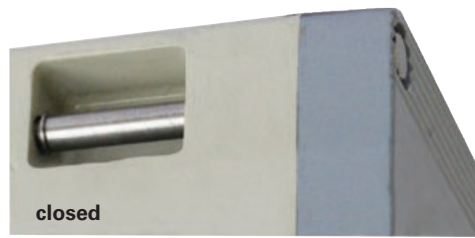

Cost-saving windows

The optional window embedded in the enclosure cover is a further useful detail. It makes it possible to monitor the display and switch states of the built-in components without additional, explosion-protected indicators that automatically increase costs.

Sealing system for low-maintenance flat flame paths.

With their optimised, low-maintenance, flat flame-paths, the standard GHG 64 enclosures feature the high degree of protection IP 65. This can be increased to IP 66 with the optional lip seal made of highly heat and weather-resistant silicone.

And that is not all! Thanks to this sealing system, the Ex-d flamepath has optimal, longterm protection against corrosion caused by the ingress of aggressive materials into the flamepath. This reduces maintenance costs and enhances safety! Enclosures protected in this way can also be used where extreme conditions may occur due to moisture, salt water, chemicals and dust, e.g. in harsh industrial environments, and offshore. Thanks to the optimised sealing, the enclosures are also ideally suited for use in areas where large amounts of dust occur, e.g. in flour and saw mills.

windows

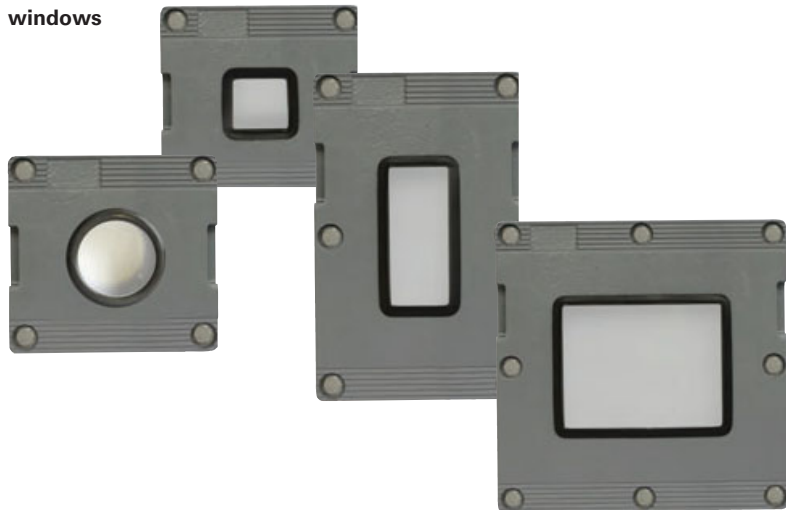

sealing lip

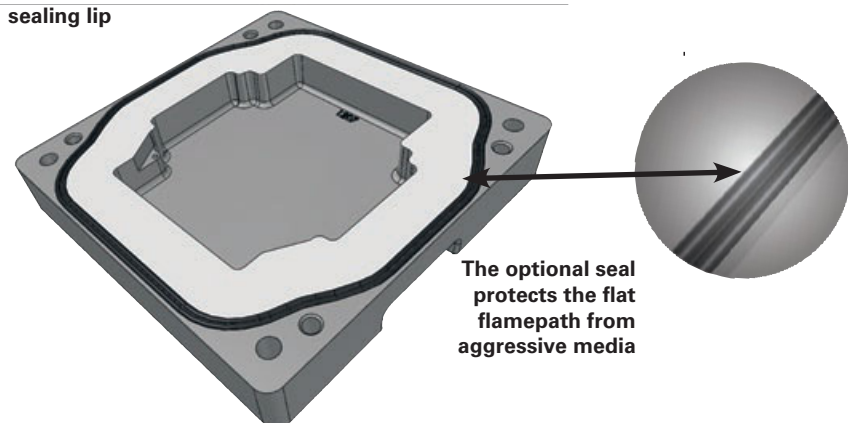



Technical data empty enclosure GHG 64

Ex-d Light alloy empty enclosure GHG 64	
Marking accd. to 94/9/EC	⊕ II 2 G Ex de IIB / IIB + H ₂ Gb / ⊕ Ex t b IIIC Db
EC-Type Examination Certificate empty enclosure	PTB 08 ATEX 1042U
Application temperature ¹⁾	-20 °C up to +40 °C / -55 °C up to +60 °C (option)
Degree of protection accd. to EN 60529	IP65 (IP66 optional)
Weight	see ordering details
Enclosure material	die-cast aluminium alloy
Enclosure colour (optionally with salt-water resistant paint finish)	RAL 7032/7022

¹⁾ depends on the test pressure of the static overpressure test of the gas group

Ordering details¹⁾/dimension drawing empty enclosure II B and IIB + H₂

Type	Dissipation (T _{amb.} = 40 °C)		Weight kg	Dimensions L x B x T	Order No. ¹⁾ IIB and IIB+H ₂	Order- number- key ¹⁾
	T6	T5				
Ex d light alloy empty enclosures, powder coated						
Size 1	94 W	134 W	10.5 kg	210 x 210 x 191 mm	GHG 640 1901 R02XX	XX 01 → IIB 02 → IIB+H ₂ ²⁾ 13 → IIB + hinge 14 → IIB+H ₂ + hinge ²⁾ 25 → IIB IP66 26 → IIB+H ₂ IP66 ²⁾ 37 → IIB IP66 + hinge 38 → IIB+H ₂ IP66 + hinge ²⁾
Size 2	112 W	158 W	14.0 kg	320 x 210 x 191 mm	GHG 640 1902 R02XX	
Size 3	140 W	195 W	17.0 kg	320 x 210 x 284 mm	GHG 640 1903 R02XX	
Size 4	152 W	214 W	18.0 kg	320 x 320 x 191 mm	GHG 640 1904 R02XX	
Size 5	197 W	280 W	21.0 kg	320 x 320 x 284 mm	GHG 640 1905 R02XX	
Size 6	240 W	335 W	22.0 kg	430 x 320 x 191 mm	GHG 640 1906 R02XX	
Size 7	270 W	390 W	27.0 kg	430 x 320 x 284 mm	GHG 640 1907 R02XX	
Size 8	270 W	390 W	35.0 kg	430 x 430 x 284 mm	GHG 640 1908 R02XX	
Size 9	390 W	430 W	53.0 kg	650 x 430 x 284 mm	GHG 640 1909 R02XX	
Size 10	470 W	640 W	73.0 kg	650 x 430 x 440 mm	GHG 640 1910 R02XX	
Size 11	470 W	640 W	105.0 kg	650 x 650 x 442 mm	GHG 640 1911 R02XX	

¹⁾ The mentioned order numbers are only for guidance and will change in case of an order, due to the fact that they describe the equipment as delivered.

²⁾ H₂ option is not available for sizes 10 and 11

Accessories

Type	Order No.
Mounting plates for components	on request

Dimension drawing

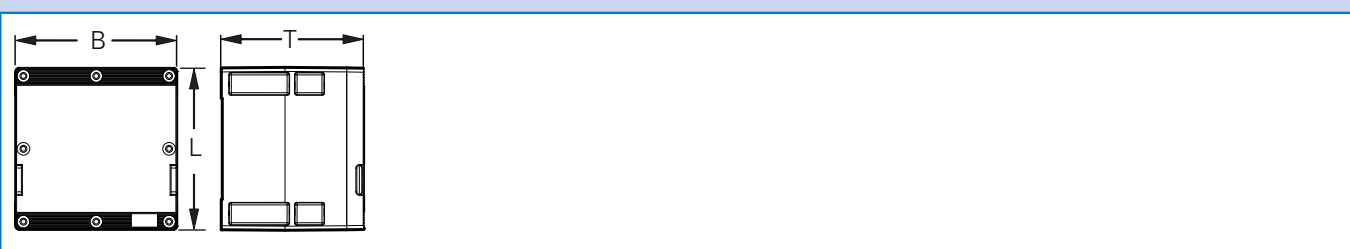

CONNECTION AND BUSBAR BOXES

Ex-e connection and busbar boxes for GHG 64

The time-proven Ex-e connection and busbar boxes are a meaningful addition to the GHG 64 range of enclosures. With these, the easy and safe realization of complex connections and current strengths of up to 630 A is standard.

Depending on customer requirements, these connection / busbar boxes, that have been adapted in an optimal way to the modular system of the flameproof enclosures, are available in stainless steel and powder-coated sheet steel and in 11 different sizes and can, therefore, be used in variable ways for a wide variety of enclosure combinations.

The various circuits of the distribution can be connected quickly and economically using a busbar system. Currents up to 1150 A are possible.

According to your requirements, individually encapsulated devices, such as control and indicator units, e.g. as pushbuttons, control switches or Ex-e measuring instruments and Ex-i digital indicating instruments can also be built into the Ex-e connection and busbar boxes.



- Ex-e enclosures that have been adapted to the modular system
- Busbar boxes in both Ex-e and Ex-d design
- Through coupling of several enclosures using busbar rails
- Rugged Ex-e enclosure made of powder-coated sheet steel or stainless steel
- Ex-d enclosure made of die-cast aluminium alloy
- Easily accessible connection terminals or busbar rails
- Easy mounting of control and indicator units in cover



Technical data terminal-/busbar boxes

Ex-e Connection box for GHG 64	
Marking accd. to 94/9/EC	Ⓔ II 2 G Ex de ia/ib [ia/ib] IIC T4 - T6 / Ⓔ II 2 D Ex tD A21 IP66 T80 °C, T95 °C, T100 °C
EC-Type Examination Certificate	PTB 00 ATEX 1073
Permissible ambient temperature	-55 °C up to +55 °C
Rated voltage/current	690 V/630 A
Connecting terminals	bis 240 mm ²
Degree of protection accd. to EN 60529	IP54 (IP66 on request)
Enclosure material	sheet steel polyester powder coated (RAL 7032) or stainless steel

Ex-e Bus-bar box for GHG 64			
Marking accd. to 94/9/EC	Ⓔ II 2 G Ex de ia/ib [ia/ib] IIC T4 - T6 / Ⓔ II 2 D Ex tD A21 IP66 T80 °C, T95 °C, T100 °C		
EC-Type Examination Certificate	PTB 00 ATEX 1073		
Permissible ambient temperature	-55 °C up to +55 °C		
Rated voltage/current	690 V/250 A	690 V/400 A	690 V/630 A
Rated short-circuit current	35 kA	53 kA	59.2 kA
Thermal rated short-time current	9.4 kA (1s)	10.7 kA (1s)	13.2 kA (1s)
Terminal cross section	bis 240 mm ²		
Degree of protection accd. to EN 60529	IP54 (IP66 on request)		
Enclosure material	sheet steel, powder coated (RAL 7032) or stainless steel		

Dimensions Ex-e connection and busbar boxes

Content	Module size	Length of - terminal rail	Weight	Dimensions in mm L x B x T
Sheet steel-connection box				
AK 1-1	1	1 x 190 mm	3.0 kg	126 x 215 x 128
AK 1-2	1	1 x 190 mm	4.3 kg	233 x 215 x 126
AK 2-1	2	1 x 300 mm	4.5 kg	150 x 325 x 128
AK 2-2	2	2 x 200 mm	7.0 kg	307 x 325 x 126
AK 4-1	4	3 x 300 mm	9.5 kg	307 x 325 x 252
AK 5-1	5	3 x 410 mm	11.5 kg	307 x 435 x 252
AK 6-1	6	3 x 630 mm	23.5 kg	407 x 655 x 252
AK 7-1	7	¹⁾ 300 mm	15.8 kg	600 x 325 x 254
AK 8-1	8	¹⁾ 410 mm	18.7 kg	600 x 435 x 254
AK 9-1	9	¹⁾ 630 mm	31.8 kg	600 x 655 x 254
AK 10-1	10	¹⁾ 190 mm	5.1 kg	452 x 215 x 128
Sheet steel-bus-bar box				
SSK 1	1	1 x 295 mm	11.0 kg	450 x 325 x 252
SSK 2	2	2 x 405 mm	15.0 kg	450 x 435 x 252
SSK 3	3	2 x 625 mm	23.0 kg	450 x 655 x 252
SSK 4	4	2 x 845 mm	31.0 kg	450 x 875 x 252

¹⁾ Number of rails dependent on terminal type

Dimension drawing

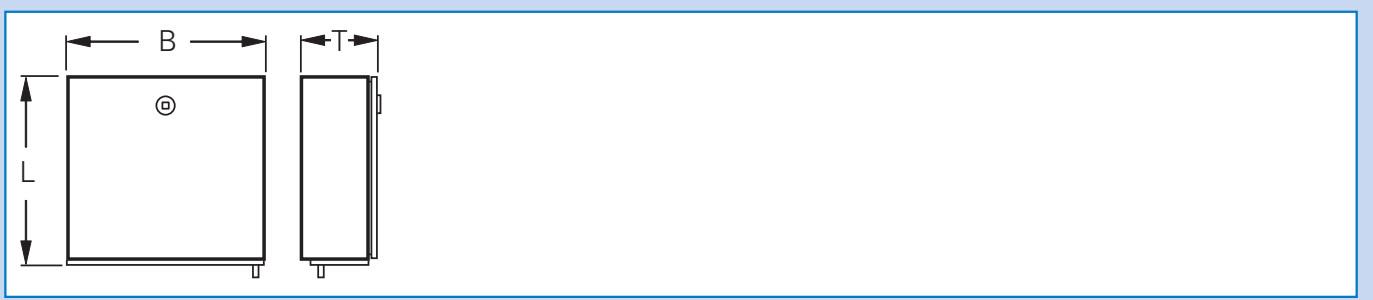

GHG 64 COMPONENTS FOR COVER MOUNTING

Variable mounting of windows, control devices and signal lamps

In addition to the use of familiar bus bar and connection boxes for built-in components, e.g. windows, switches, indicating devices, actuators and switch blocks, a direct use of flameproof enclosures for Ex-d cover-mounting devices is also possible. The result is a multitude of possible combinations for the configuration of complex controls.

6 In accordance with your specifications, threaded Ex-d holes for accommodating the desired screw-in components are drilled into enclosure covers in our works.

Thanks to the modular design of the pushbuttons, switch contact blocks can be exchanged at a later point in time. By simply undoing a bayonet connection inside the enclosure, individual contacts such as NC or NO can easily be replaced by multiple contact blocks without affecting the explosion protection. Here the extension of individual contacts to multiple contacts with up to four NC or NO contacts is possible.

Longlife LED lamps ensure safe operation on a lasting basis. Windows allow the monitoring of the built-in components. Ex-d actuating elements for various circuit breakers, such as mushroom-head pushbuttons, key-operated switches or photocell inserts, complete the product range.

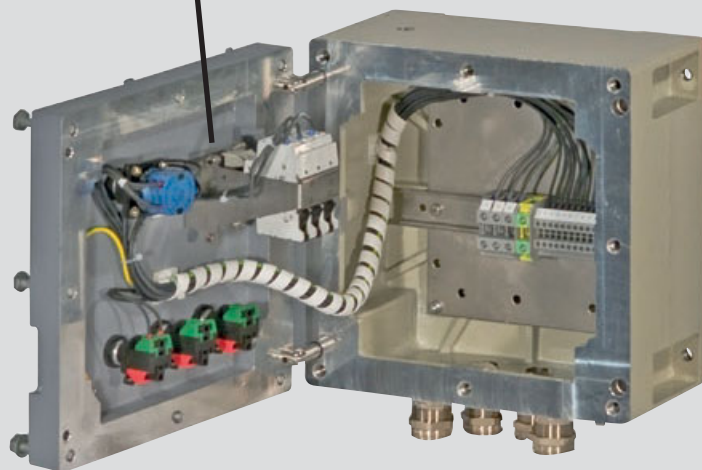

- Variable mounting of windows, actuators and signal lamps
- Rotary switches for main switch
- Pushbuttons with up to four contacts
- Pushbuttons with Emergency Stop function
- Key-operated switches/pushbuttons
- Signal lamp in various colours
- Padlocking facilities
- Nameplates
- Actuating elements for circuit breakers (MCBs)



Technical data components for cover mounting

Built-in Ex d control units / indicator elements / actuators for GHG 64	
Marking accd. to 94/9/EC	Ⓔ II 2 G Ex d II
EC-Type Examination Certificate	PTB 06 ATEX 1009U
Operating temperature range	-20 °C up to +70 °C -20 °C up to +100 °C (option)
Application temperature ¹⁾	-20 °C up to +40 °C -20 °C up to +55 °C (option)
Rated voltage switch base	up to 500 V
Rated voltage indication lamps	230 V
Rated current switch base	up to 63 A
Degree of protection accd. to EN 60529	IP65 (IP66, listed switch base up to 10 A, optional)
Fixing thread Ex-d	M22 x 1.5

Ordering details

Type	Content	Order No.
Switch base		
	1 NO	GHG 640 9617 P0001
	1 NC	GHG 640 9617 P0002
	1NO + 1 NC	GHG 640 9617 P0003
	2 NO	GHG 640 9617 P0004
	2 NC	GHG 640 9617 P0005
	2 NO + 1 NC	GHG 640 9617 P0006
	1 NO + 2 NC	GHG 640 9617 P0007
	2 NO + 2 NC	GHG 640 9617 P0008
	3 NO + 1 NC	GHG 640 9617 P0009
	1 NO + 3 NC	GHG 640 9617 P0010
4 NO	GHG 640 9617 P0011	
4 NC	GHG 640 9617 P0012	

Type	Content	Order No.	Thread length	
Pushbutton			25 mm	40 mm
	yellow	GHG 640 9607 P0011		
	blue	GHG 640 9607 P0012	P0022	
	red	GHG 640 9607 P0013	P0023	
	green	GHG 640 9607 P0014	P0024	
	white	GHG 640 9607 P0015	P0025	
	black	GHG 640 9607 P0016	P0026	
Key-operated pushbutton				
	with 2 keys	GHG 640 9608	P0011	P0012

Type	Content	Order No.	Thread length	
Signal lamp			25 mm	40 mm
	green	GHG 640 9614 P0011	P0021	
	red	GHG 640 9614 P0012	P0022	
	yellow	GHG 640 9614 P0013	P0023	
	blue	GHG 640 9614 P0014	P0024	
	farblos	GHG 640 9614 P0015	P0025	

Type	Content	Order No.	Thread length	
Mushroom-head / EMERG.STOP pushbutton			25 mm	40 mm
	D 36 mm with lock	GHG 640 9603	P0011	P0013
	D 50 mm with lock	GHG 640 9603	P0012	P0014
	with twist-release	GHG 640 9604	P0011	P0012
	EMERG.STOP pushb.	GHG 640 9606	P0011	P0012

Ex-d(e) control units, control switches, terminal boxes and distributions can be built in accordance with EC-Type Examination Certificate PTB 08 ATEX 1043X

Ex-d Built-in components



Rotary switch base mounted

Rotary switch cover mounted



Photocell

Window, round

Window, square/rectangular

Ordering details

Type	Content	Order No.
Main switch up to 1000 A 	Rotary switch for cover	
	Switch 20 A/ 32-63 A	GHG 640 9612 P0001
	Switch 20 A/ 63-100 A	NOR 000 001 170 030
	Switch 20 A/ 100-250 A	NOR 000 001 170 031
	Switch 20 A/ 250-1000 A	NOR 000 001 170 032

Type	Content	Order No.
Window  	square, 60 x 60 mm	on request
	rectangular, 140 x 60 mm	on request
	rectangular, 140 x 180 mm	on request
	round, Ø 80 mm	on request

Type	Content	Order No.
Photocell 	250 VAC / 10 A	GHG 640 9601 P0003

Type	Content	Order No.
Padlocking-facility 	Pushbutton engaged	GHG 640 9614 P0001
	Pushbutton released	GHG 640 9614 P0002

Ex-d(e) control units, control switches, terminal boxes and distributions can be built in accordance with EC-Type Examination Certificate PTB 08 ATEX 1043X.

With us you have the choice

With us you always have the possibility of choosing between fully configured standard and customised equipment with direct cable entries, flameproof connection compartments or Ex-e connection compartments according to your requirements.



6

Customised solutions

We can supply you with an individual solution customised according to your wishes. We deliver individual units, combinations on wall or floor-mounting frameworks or freestanding for operation from both sides that are ready for connection to any place in the world.

Based on your specific requirements, we put together all the necessary components, assemble them with your specific built-in components, test all the functions and deliver them within the agreed time to the specified location. It goes without saying that the Cooper Crouse-Hinds CE Declaration of Conformity also observes and takes the built-in industrial components into consideration and, what is more, our customised solutions are also covered by other available national approvals, thus allowing you to concentrate fully on your core business. .

Our standard solution

As with the GHG 66 enclosure series, we also supply the GHG 64 enclosure series with fully assembled products, e.g. manual motor starters for direct, reversing and star-delta switching, as well as safety switches for up to 800 A, four-pole, and standard distributions with circuit breakers. These units have their own order numbers, have been fully tested and can be supplied at short notice.

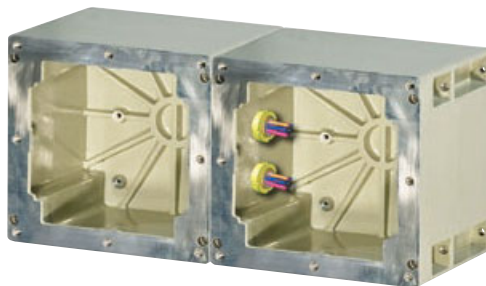

Variable GHG 64 enclosure concept for optimized customer solutions

You have your specific requirements for which we provide the appropriate solution:

- Ex low-voltage distributions
- Ex motor controls
- Ex lighting circuit distribution systems
- Ex heating circuit distribution systems
- Ex instrumentation applications
- Ex wireless LAN

Depending on the task in hand and taking the specified size and technology or specific ambient conditions into consideration, e.g. aggressive media, harsh industrial conditions or offshore applications, we engineer the optimum GHG 64 Ex-d distribution system for you as a solution for the most cost-effective, local control/power distribution in a hazardous area.

With this modular system, all enclosure sizes are fully compatible, thus making it possible to flange several smaller enclosures onto the large enclosures, whereby they are flush with all the adjacent areas. Thus, any distribution required can be realized using flameproof connections or connection and busbar boxes.

We can, of course, also integrate customer-specific functional units, such as frequency converters or electronic sub-assemblies, into our Ex-d solution as built-in apparatus.

According to your inquiry, we submit an optimum solution proposal for your required application.

- Compact design
- IIB + H2 applications
- Cost optimization thanks to low maintenance flat flamepaths
- and the compact design
- Can be used in extreme ambient temperatures from -55°C to +55°C
- Wide range of actuators
- Copper-free aluminium with high quality powder coating
- Up to IP 66 to EN 60529





Technical data

Ex-d Motor starter	
EC-Type Examination Certificate	PTB 08 ATEX 1043X
Marking accd. to 94/9/EC	⚡ II 2 G Ex d IIB / IIB + H ₂ T5, T6 Gb ⚡ II 2 D Ex tb IIIC T80 °C, T95 °C Db IP66
IECEX Certificate of Conformity	IECEX PTB 11.0077 X
Marking accd. to IECEX	Ex d IIB + H2 T6, T5, T4 Gb
Permissible ambient temperature	-20 °C up to +40 °C -55 °C up to +55 °C (option)
Rated voltage	up to 690 V
Rated current	up to 100 A
Connecting terminals	up to 400 mm ²
Degree of protection accd. to EN 60529	IP65 (IP66 optional)
Weight	see ordering details
Enclosure material	die-cast aluminium
Enclosure colour	RAL 7032/7022

6

Ordering details

Content Motor capacity to AC 3	Main switch	Cable entry	Weight approx.	Order No.
11 kW	25 A	3 x M25	13.0 kg	on request
15 kW	25 A	2 x M32 / 1 x M25	23.0 kg	on request
22 kW	40 A	2 x M40 / 1 x M25	35.5 kg	on request
Reversing circuit				
11 kW	25 A	3 x M25	13.5 kg	on request
15 kW	25 A	2 x M32 / 1 x M25	23.5 kg	on request
22 kW	40 A	2 x M40 / 1 x M25	36.0 kg	on request
Star-delta starter				
7.5 KW	40 A	4 x M25	23.5 kg	on request
12.5 KW	40 A	4 x M25	24.0 kg	on request
18.5 KW	40 A	3 x M32 / 1 x M25	37.0 kg	on request
30.0 KW	63 A	3 x M32 / 1 x M25	38.0 kg	on request
37.0 KW	100 A	1 x M40 / 2 x M32	63.0 kg	on request
55.0 KW	100 A	1 x M40 / 2 x M32 1 x M25	63.0 kg	on request

Complex requirements for local explosion-protected controls

In addition to the stringent enclosure requirements, in the case of controls special emphasis is placed on the clear arrangement of the control and indicating elements.

For example, in the case of marine applications. The illustrated control unit is used for the operation of two electric motors of the hydraulic pump of the ship loading arm in a hazardous area that is classified as Group IIB.

This is a challenging task, as the components in the required compact design always have to be easily accessible. Here we were able to offer the customer an optimised solution that completely fulfils the given specifications using the GHG 64 concept.



Further applications of this kind, where a high degree of protection and compact design are required, are not only found in the oil and gas industries in installations for loading operations onshore and on offshore platforms or on oil or gas tankers, but also in pharmaceutical plants, at suppliers and in areas with Ex dust applications, e.g. in areas where sacks are emptied, mills and mixers, filling installations, etc.

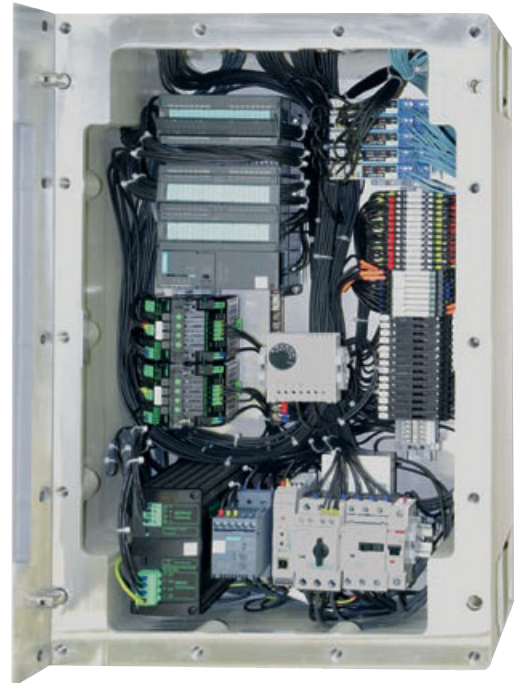

Wireless solutions for the processing industry

New radio systems make reliable wireless communication for measuring and control applications possible. The demand for solutions in the processing industry is growing all the time. The range of possible applications even covers the equipment/field level. Here we are working together closely with MTL, the leading manufacturer of industrial radio systems, and can supply you with complete solutions on the basis of our GHG 64 enclosure system. This means that you can use various systems with open interfaces. The requirement profiles for the hardware are complex.

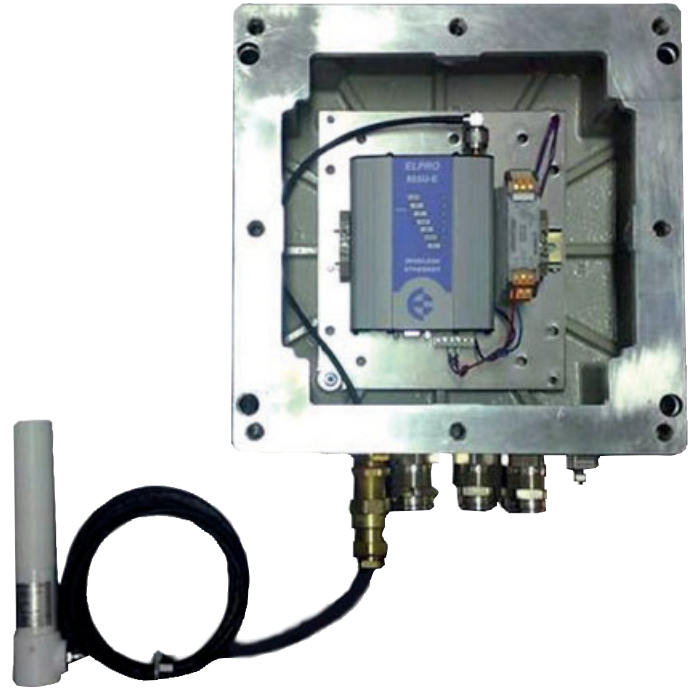

6



Intelligent instrumentation

Thanks to the GHG 64 enclosure concept, it is possible to combine the reliable safety of a modular, explosion-protected enclosure concept with the advantages of a continuous communications infrastructure between the main, control and process levels. Here, for example, Ethernet-based communication systems can also be used in hazardous areas. This allows the use of a modern information architecture and, at the same time, the efficient adherence to all the explosion protection criteria.